

A large graphic featuring the letters 'MCIA' in a bold, sans-serif font. The 'M' is blue, while 'CIA' is white. The letters are set against a circular background with a blue circuit board pattern. To the right of the 'A', there are two orange circuit traces with circular nodes.

**M** **CIA**

**MCIA Center**  
**Innovation Electronics**  
*Universitat Politècnica de Catalunya*

**TECNIO**  
Be tech. Be competitive

	<b>PROFILE</b>	Author	MCIA Center
	<b>MCIA CENTER <i>INNOVATIONS ELECTRONICS</i></b>	Code / Rev.	3
		Date	2011
		Type	PUBLIC
		Page	2 of 32

*This page is intentionally left blank*

	<b>PROFILE</b>	Author	MCIA Center
	<b>MCIA CENTER <i>INNOVATIONS ELECTRONICS</i></b>	Code / Rev.	3
		Date	2011
		Type	PUBLIC
		Page	3 of 32

## Contents

<b>1. Center Presentation.....</b>	<b>5</b>
<b>2. History .....</b>	<b>5</b>
<b>3. Contact.....</b>	<b>6</b>
<b>4. Research Areas .....</b>	<b>7</b>
<b>5. Research and Development Capabilities.....</b>	<b>10</b>
<b>6. List of selected Industrial Projects .....</b>	<b>17</b>
<b>7. International Publications .....</b>	<b>20</b>
<b>8. Patents.....</b>	<b>23</b>
<b>9. Organization and management of the investigation.....</b>	<b>24</b>
<b>10. Human Resources Capacities .....</b>	<b>31</b>
<b>11. Potential options of collaboration.....</b>	<b>32</b>
<b>12. Infrastructure and technical equipment.....</b>	<b>25</b>
<b>13. Formation Capabilities .....</b>	<b>28</b>

	<b>PROFILE</b>	Author	MCIA Center
	<b>MCIA CENTER <i>INNOVATIONS ELECTRONICS</i></b>	Code / Rev.	3
		Date	2011
		Type	PUBLIC
		Page	4 of 32

*This page is intentionally left blank*

	<b>PROFILE</b>	Author	MCIA Center	
		Code / Rev.	3	
	<b>MCIA CENTER <i>INNOVATIONS ELECTRONICS</i></b>		Date	2011
			Type	PUBLIC
			Page	5 of 32

## 1. Center Presentation

The MCIA Center is part of the Technical University of Catalonia, located in Terrassa. The Center staff comes from Aerospace and Industrial Engineering Schools. The center activities are diversified in *scientific research*, but also *applied research* and *technology transfer* to the industry.

The contacts with local industry and research groups on Terrassa Campus are common and have been intensified in recent years, resulting in the participation and leadership of numerous research projects and technology transfer contracts with public and private funding.

The work areas and key knowledge of the group can be summarized in the following main points:

**Systems Diagnosis**

**Energy Management**

**Industrial Electronics**

## 2. History

*1997* MCIA is created within the Electronic Engineering Department of the Technical University of Catalonia (UPC) in Terrassa Campus.

*2003* MCIA is established in a new research line within the Electronic Department.

*2004* MCIA receives the *Research Group* recognition from the UPC.

*2005* MCIA is recognized by the Generalitat of Catalonia (Country Government) as *Emerging Research Group* (SGR2005-00463).

*2007* MCIA takes part into the *Network of Support Centers for Technological Innovation*, TECNIO of the Generalitat of Catalonia.

*2009* MCIA increases its activity and moves to a specific research building (GAIA) in Terrassa Campus.

*2011* MCIA expands its laboratories up to 200m<sup>2</sup>.

	<b>PROFILE</b>	Author	MCIA Center	
		Code / Rev.	3	
	<b>MCIA CENTER <i>INNOVATIONS ELECTRONICS</i></b>		Date	2011
			Type	PUBLIC
			Page	6 of 32

### 3. Contact

#### Research Center location:

Address: Rambla Sant Nebridi s/n. Gaia Research Building.  
Campus UPC Terrassa, 08222, Barcelona, Spain

Email: [info@mcia.upc.edu](mailto:info@mcia.upc.edu)

Phone: +34 93 739 85 30

Fax: +34 93 739 89 72

Website: [www.mcia.upc.edu](http://www.mcia.upc.edu)

#### Research Center Director:

##### **Dr. Luis Romeral**

Address: Rambla Sant Nebridi s/n. Gaia Research Building.  
Campus UPC Terrassa, 08222, Barcelona, Spain

Email: [luis.romeral@mcia.upc.edu](mailto:luis.romeral@mcia.upc.edu)

Phone: +34 93 739 85 10

Fax: +34 93 739 89 72

	<b>PROFILE</b>	Author	MCIA Center	
		Code / Rev.	3	
	<b>MCIA CENTER <i>INNOVATIONS ELECTRONICS</i></b>		Date	2011
			Type	PUBLIC
			Page	7 of 32

## 4. Research Areas

The MCIA Center working areas can be grouped in: System Diagnosis, Energy Management and Industrial Electronics. However, each of these three areas can be divided in more specific subareas.

### 4.1. Systems Diagnosis.

**On-line condition monitoring**

**Supervision and fault detection**

**Motor drives safety**

**Non-destructive tests**

Activities in *motor control* have now given way to research on *supervision and diagnostics systems*. The initial work on electrical actuators has shown that the current needs of the industry are the development of techniques for diagnosis and monitoring of its electromechanical systems. Research in this area is focused on improving the classical diagnostic techniques by providing new techniques for *signal processing, pattern recognition and expert systems*.

Recently all these techniques have been implemented for an aeronautical project with high reliability requirements. The MCIA Center collaborated on the project *MOET: "More Open Electrical Technologies"* from 6<sup>th</sup> Framework Program of the European Union, a project aimed to create new standards for electrical systems of commercial aircrafts.

The MCIA Center was working on electromechanical actuators of the primary flight control ailerons, particularly in the detection and diagnosis of single and combined motor failures.

As a clear evolution of *motor diagnostics*, the center activities have evolved into the diagnostics in general for other systems. The merge of instrumentation and processing capabilities with *intelligence systems* allow the development of high added value systems that are becoming more common since are the natural evolution of the traditional systems for the products which are already in the market. Experience in this area ranges from surveillance projects, biometrics for access control and verification personnel to *quality control systems* for the industry.

Recently, a *non-destructive tests* research line related with electromechanical systems has started. The application into the industry of non destructive tests is a key for the increase of quality of the products and maintains the quality of the product against the competitors.

	<b>PROFILE</b>	Author	MCIA Center
	<b>MCIA CENTER <i>INNOVATIONS ELECTRONICS</i></b>	Code / Rev.	3
		Date	2011
		Type	PUBLIC
		Page	8 of 32

## 4.2. Energy Management.

**High Voltage transportation**

**Micro-grid management**

**Renewable microsources**

**Energy quality**

**Demand-response optimization**

**HVAC systems**

The energy optimization is a worldwide interest topic, and the MCIA Center is involved in the area. The *energy optimization* is the newest research MCIA line, and it is the one that is growing faster. The knowledge in control and detail of industrial facilities coupled with the work in *digital processing* and *artificial intelligence*, offers added value to the MCIA research and technology transfer in this area. Energy optimization projects range from *consumption optimization* up to *intelligent control* of power micro grids, including renewable power generators and loads. Inside this area, the center is also developing *energy audits* for Industrial facilities that are the first step to optimize efficiently.

The MCIA Center is becoming gradually a technology partner to consider for more comprehensive projects. This is evidenced by agreements with companies, such as the development of a new standard electrical system for pleasure boat using optimization algorithms, or a more recent project to apply the same philosophy into the facilities of one of the major car manufacturers in Spain.

Other branch in energy optimization that it has been included in the MCIA activities is the *high voltage transportation* where different projects have being developed as the characterization of the corona effect produced in high voltage AC transmission systems.



	<b>PROFILE</b>	Author	MCIA Center
	<b>MCIA CENTER <i>INNOVATIONS ELECTRONICS</i></b>	Code / Rev.	3
Date		2011	
Type		PUBLIC	
Page		9 of 32	

### 4.3. Industrial Electronics.

**Motor control and electric machines design**

**Power electronic converters and control**

**Instrumentation and signal equipments**

**Digital control of systems and equipments**

**Industrial communications and wireless networks**

**Data mining and signal processing**

Historically, the fundamental research activities of the group started in the field of *electric motor control*. Most of the effort was devoted to exploring various *motor control strategies*, initially for induction motors and more recently of PMSM, radial and axial flux, and SRM. Techniques under consideration range from traditionally control schemes to improved FOC or DTC.

During the projects of diagnostic, the center has also gained experience and knowledge in *instrumentation* because as the diagnosis became more and more complex and precise, the ability to have specific instruments to measure was essential. In return, these diagnostic systems have become more efficient and capable to integrate into larger systems.

This integration of the instrument into bigger systems led the MCIA Center to develop expertise in *data acquisition and communications*, and later, the data acquired by the instrumentation had to be sent to the processing center and the results, sent to the user that could be very far using remote control over Internet.

	<b>PROFILE</b>	Author	MCIA Center
	<b>MCIA CENTER INNOVATIONS ELECTRONICS</b>	Code / Rev.	3
Date		2011	
Type		PUBLIC	
Page		10 of 32	

## 5. Research and Development Capabilities

Since its foundation, the MCIA Center has participated in some National and International projects. It is presented next a brief summary of the last projects participations and leaderships, additionally some projects are explained with more detail.

### 5.1. National/International Programs participation and projects leadership

1. **VERDE**, "*Vehículo Eléctrico. Respuesta a la Dependencia Energética.*", CENIT lead by SEAT;  
The MCIA Center takes part in the different activities which form the research and the technologies development for allowing a reliable and economic introduction of electric and hybrid vehicles in the Spanish automotive market. The related activities range from development of traction systems, converters for battery management and energy storage systems to vehicle recharge infrastructure and communications.
2. **LOTPIM**, "*Low cost, predictive maintenance system for industrial machinery, based on Induction Motor Current Analysis, Wireless Network and Self-Power technologies*", FP6 project lead by CRIC;  
MCIA Center participated in the development of a diagnostic system of asynchronous motors by stator current analysis. The system was autonomously powered and connected by wireless with a main monitoring station.
3. **MOET**, "*More Open Electrical Technologies*", FP6 project lead by AIRBUS.  
MCIA collaborates with the company GOODRICH France to develop a diagnosis and anticipation system of failures for new primary electromechanical actuators in airplanes equipped with PMSM motors.
4. **CAR-ECOLOGY**, "*New Technological and Ecological Standards in Automotive Engineering*", European Master founded by UE Education and Culture Lifelong Learning Programme.  
Project financed by the European Community to develop a European Master about electric and hybrid vehicles technologies. The project is developed with collaboration of universities from Belgium (KdG), Germany (Köln), Poland (Wroclaw), Austria (Graz), Greece (Thessaloniki) and Spain (Valencia).
5. **RUE**, "*Advanced Wide Band Gap Semiconductor Devices for Rational Use of Energy*", CONSOLIDER-INGENIO lead by CNM.  
The main objective of this project is to develop a real first generation of new Wide Band Gap power semiconductor devices that allow both an important improvement in the performance of existing converters and the development of new power converters; in both cases seeking a more rational use of the electric energy.
6. **RESAMCAR**, "*Research on Axial Flux Permanent Magnet Motor Drive for in-Wheel Car Applications: Electromagnetic and Power Electronics Technologies*", CICYT lead by MCIA.  
The main objective of this project is to develop a real first generation of new Wide Band Gap power semiconductor devices that allow both an important improvement in the performance of existing converters and the development
7. **DIAGMAN-MECH.AUTO**, "*Detection and Diagnosis of failures for predictive maintenance of mechatronic systems*", CICYT lead by MCIA.  
The project, in collaboration with Rovira i Virgili University (URV), was based on investigation of control, supervision, procedure, diagnosis and forecast technologies for overland and aeronautic transport industry applications.
8. **CONDIAG-MIP**, "*New techniques of Control, Supervision and Diagnosis oriented to improve the performance of electrical drives with Permanent Magnet Synchronous Motor*", CICYT lead by MCIA.  
The Project studied and developed new strategies of sensorless control, as well as the analysis and development of an intelligent algorithm of detection and diagnostic failures in high efficiency PMSM machines.

### 9. and others...

	<b>PROFILE</b>	Author	MCIA Center	
		Code / Rev.	3	
	<b>MCIA CENTER INNOVATIONS ELECTRONICS</b>		Date	2011
			Type	PUBLIC
			Page	11 of 32

## 5.2. Detailed explanation of some selected projects

### 5.2.1. VERDE, Spanish Government Research Project (2010-2013).

The CENIT VERDE Project includes objectives which will allow in the future, the development of products with international importance in the electromobility field. The project's objectives go beyond the research of technologies to develop revolutionary products related with Plug in Hybrid Electric Vehicle (PHEV) and Electric Vehicles (EV). The main points to assure the competitiveness of the companies are analyzed: Spanish automotive, power electronics and electric network distribution sectors are included. The VERDE Project is structured in seven main Activities:

**Activity 1:** Study and definition of mechanical and electrical technologies in the electric vehicle. Design and analysis of new electronic architecture applied on PHEV/EV. Moreover, operating ranges components selection and research and development of control and supervision algorithms.

**Activity 2:** Research and development of energy storage systems.

Study and development of technologies used in massive energy storage in PHEV/EV, especially chemical technology, with more capacity and less weight and volume than the current solutions.

**Activity 3:** Research and development of traction systems.

Research and the development of electronic technologies for PHEV/EV actuators design with more power density, more reliability and less weight than the current ones.

**Activity 4:** Design and control of charge and discharge converters for battery management.

The main objective of this activity is focused in the development of a high power and density bidirectional battery charger able to be connected to the communication infrastructure.

**Activity 5:** Local infrastructure system for energy recharge.

Connection technologies development between PHEV/EV and the electrical network, taking into account the bidirectional energy transfer, the energy supply and services invoicing.

**Activity 6:** PHEV/EV integration in the electric system: infrastructure, networks and services.

The objective consists in the analysis of the PHEV/EV integration in the electrical distribution network from a global point of view, and the stability and impact factor study in the current electrical network.

**Activity 7:** Integration and validation of the developed technologies for PHEV/EV.

The activity includes the experimental validation of the chemical and electro-mechanical technologies and developed algorithms over a demonstrator. Moreover, the criteria for PHEV/EV normalization are included in this activity.

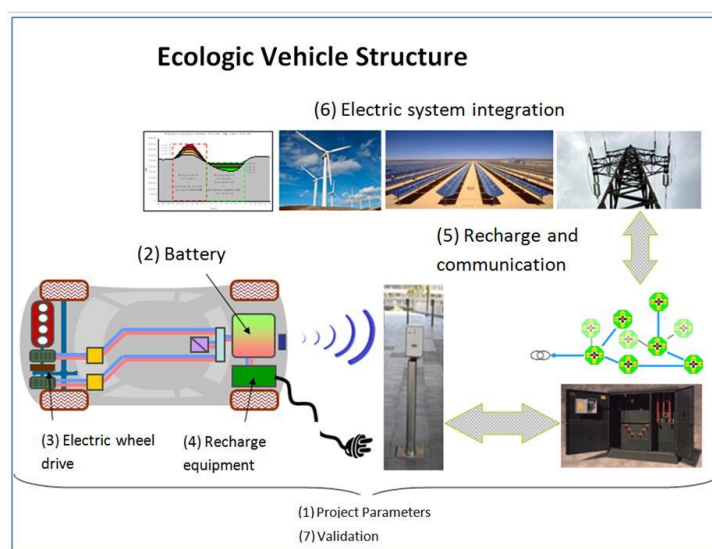

### 5.2.2. LOTPIM, European Union Research Project (2005-2007).

With the growing adoption of electronics in today's industrial systems, increasing reliability is often hampered by the failings of mechanical components. Reliability is a major issue in today's highly competitive marketplace, the costs associated with unexpected machine failure having potentially drastic effects on a company. Predictive maintenance systems and services are very often unaffordable for SMEs. Therefore there is a need for a low cost means of non-subjective on-line, pre-vibration condition monitoring system for detecting malfunctions in gearboxes, rotating shafts, bearings and similar systems. Currently, only the largest, most critical motors are monitored. Leveraging new, inexpensive RF components and integration techniques, along with advances in microprocessor technology, it is possible to provide an economic solution for wirelessly monitoring motor operating parameters - such as temperature, vibration, current, etc. - for all classes of motors, thus creating enormous potential for energy and cost savings.

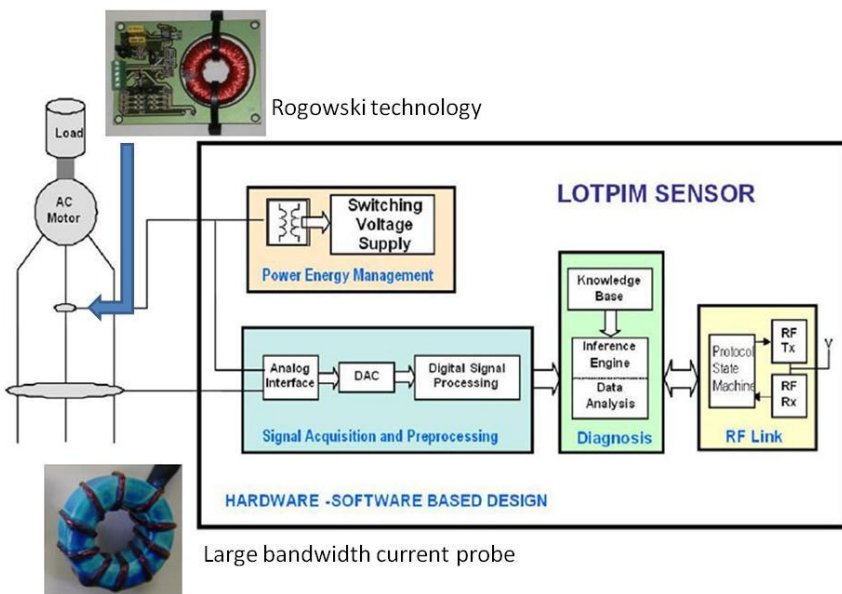
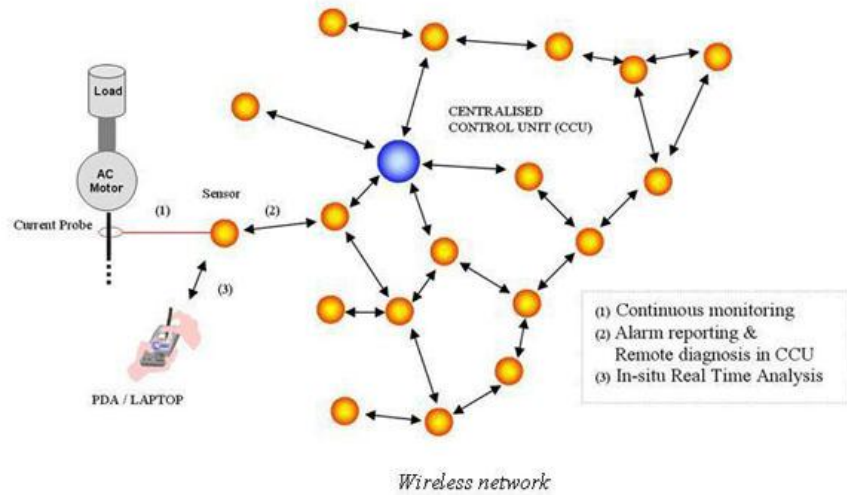

The proposed LOPTIM technology will surpass the state of the art by utilizing the novel combination of stator current analysis, along with the current flow from the inverter to the motor and machinery for continuous pre-vibration monitoring. LOPTIM will combine self-powered innovative technology, artificial intelligence and a wireless communication network that will render the device both intelligent and autonomous, allowing continuous centralized

monitoring of the plant at a fraction of the cost of current alternatives. The generic technology will find applications in areas where motors, pumps, gearboxes or drive chains need to be monitored on a continuous basis, such as fluids processes in chemical industries, motor – generator systems, serial trunk conveyor systems, and general line production in manufacturing industries.

	<b>PROFILE</b>	Author	MCIA Center	
		Code / Rev.	3	
	<b>MCIA CENTER <i>INNOVATIONS ELECTRONICS</i></b>		Date	2011
			Type	PUBLIC
			Page	13 of 32

### 5.2.3. MOET, EU 6th Framework programme (2007 – 2009).

In line with the vision 2020, MOET aims to establish the new industrial standard for commercial aircraft electrical system design, which will directly contribute to strengthening the competitiveness of the aeronautical industry. MOET will also contribute to reduce aircraft emissions and improve operational aircraft capacity.

Recent National and European research activities and state of the art commercial aircraft developments have launched more advanced approaches for on-board energy power management systems. These benefits have also been recognized in North America where this has been given special consideration. A step change is necessary to remove current air and hydraulic engine off-takes and further increase the electrical power generation capability. This in itself will require significant changes to current electrical generation and network techniques. After Fly by wire, the Power by wire concept (PbW) will enhance aircraft design and use by power source rationalization and electrical power flexibility. This will be achieved by developing the necessary design principles, technologies and standards.

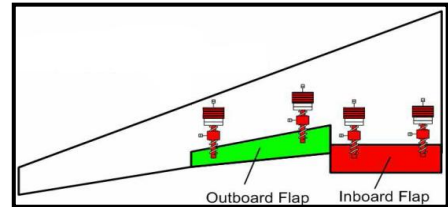
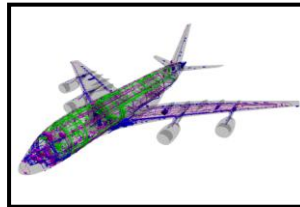

Over a 3-year period, MOET has allowed to:

- Validate scalable electrical networks up to 1MW considering new voltages and advanced concepts including system transformation of future air, actuation and electrical systems into all electrical solutions.
- Assess the PbW concept integration at aircraft level considering a more composite environment and the interfaces with the avionics world.
- Build a design environment aiming to design and validate standard solutions and a coherent set of platforms open to the full supply chain, in order to develop an optimized high performance PbW concept.

One of the work package aims to develop Electro-Mechanical Actuation concept which is the new technology objective to answer to PbW as regards aircraft Primary Flight Controls. Furthermore, this innovative EMA will be based on a Direct Drive architecture which presents benefits in terms of overall dimensions / weight optimization. This technology has been up today developed for train and launchers applications. MCIA developed the diagnostic software and their validation of the motor of the actuator of the aircraft Primary Flight Controls.

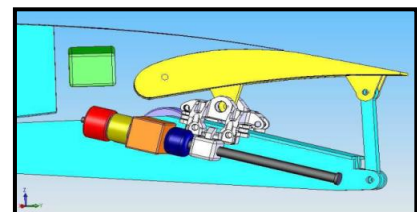

	<b>PROFILE</b>	Author	MCIA Center
		Code / Rev.	3
	<b>MCIA CENTER INNOVATIONS ELECTRONICS</b>	Date	2011
		Type	PUBLIC
		Page	14 of 32

#### 5.2.4. RESAMCAR, Spanish Government Research Project (2010-2012).

Electric Vehicle (EV) Technologies are currently high on academic and industrial research agendas. The electrical motor drive is the key part in EV and the only propulsion system in battery EV. Traction motors for EV are different from motors applied in industry. Load features are constant torque in low speed and constant power in high speed. General characteristics of these motors should be high power and torque density, extended speed range (ratio of maximum speed to base speed usually larger than four), high efficiency over whole work area, shockproof, waterproof, and dustproof. Sensorless controls are fit for the application. Advanced control and supervision for fault detection and fault tolerance capacities for the whole electrical drive are also required.

Therefore, improvements in electromagnetic and mechanical designs, control of an electrical machine and constructive motor materials as a part of a traction system for EVs are the main finality of this project. Research of electric motors and its control algorithms to find the most suitable motor for EV is being an ongoing process keenly pursued by researchers throughout the world. Because it is very difficult to identify a unique drive solution for all electric vehicles (city cars, luxury cars, minivans, trucks, etc.), the project focused their attention on motor drives for small electric city cars to be used in Spanish and European cities where the environmental pollution problems are quite heavy. This kind of medium and small power vehicles result particularly adapted to mount the known as “in-wheel motor system”. In such a system, the motor is mounted directly into the wheel, and neither transmission gears nor mechanical differential gears for mechanical power transmission from the electric motor to the wheels are necessary. For this application, axial flux machines that run the flux in the axial rather than the radial direction result especially convenient. The usage of permanent magnets in combination with the axial-flux architecture leads to a combined concept referred as the “axial-flux permanent-magnet” (AFPM) machines.

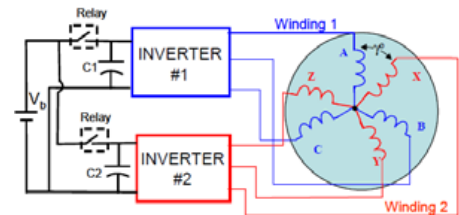
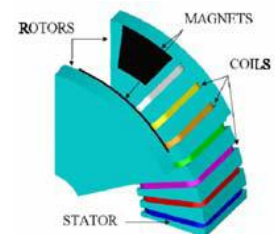

Therefore, conceptualization, proposal and experimental validation with high performance control of a fault tolerant axial flux machine for an “in-wheel” motor to be installed into a small or medium electric car is the main objective of this project. The major fields of research are as follows:

- Detection and identification of faults in a drive with an AFPM machine for an electrical power train, including motor mechanics and power converters.
- Fault tolerant capability of an AFPM electric drive for electric cars, including new motor and power converter conceptualizations and designs.
- Improvements of the AFPM drive efficiency along the full speed range by both advance control and improved magnetic materials and heat sinks.

	<b>PROFILE</b>	Author	MCIA Center	
		Code / Rev.	3	
	<b>MCIA CENTER INNOVATIONS ELECTRONICS</b>		Date	2011
			Type	PUBLIC
			Page	15 of 32

### 5.2.5. DIAGMAIN – MECHAUTO, Spanish Government Research Project (2007-2010).

The project is focused on the investigation of fault detection of mechatronic systems in order to achieve an optimal diagnosis in high efficiency actuators for robotics, aeronautics, and auxiliary automotive drives applications. The investigation will be specially applied to the new motors used in aeronautical applications and high efficiency actuators, PMSM (Permanent Magnet Synchronous Motor) and new automotive drives, PMSM and SRM (Switched Reluctance Motors).

Specifically, the project aims Investigation, Development and Validation of a Multimodal Expert System for the Diagnosis and Prognosis of the whole mechatronic system, which means the combination of electronic power converters, high efficiency AC motor and associated mechanical coupling to the load.

To achieve this objective, the isolated diagnosis of each component of the mechatronic system, i.e., Power Converter, Motor and Gearboxes will be investigated. Data bases and unimodal expert systems will be also investigated and developed for every component of the mechatronic system. Interrelations under fault state, between these components will be studied.

A multimodal expert system for the total mechatronic system will be obtained by fusion of unimodal experts above explained. This multimodal expert will consider every interrelation between individuals to locate, identify, diagnose and quantify the fault.

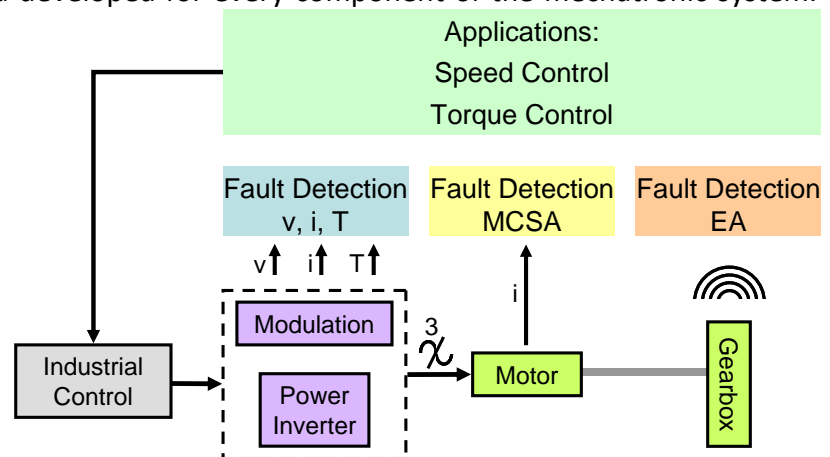

The two main objectives and its sub-objectives of the project are as follows:

- Progress in the Fault Detection and Fault Location on a mechatronic system:
  - Development of full models for faulty and healthy PMSM and SRM motors
  - Investigation on the gearboxes and other motor mechanical coupling
  - Investigation on the fault detection methods for power converters
- Investigation and Development of a Multimodal Expert System for the Diagnosis and Prognosis of the whole mechatronic system used in auxiliary automotive and industrial/aeronautical applications
  - Development of a Multimodal Expert System, MES
  - MES validation on an automotive drive application: Power Converter, SRM Motors and Air Conditioning Compressor.
  - MES validation on a high efficiency actuator: Power Converter, PMSM Motor and Gearbox

	<b>PROFILE</b>	Author	MCIA Center
	<b>MCIA CENTER INNOVATIONS ELECTRONICS</b>	Code / Rev.	3
		Date	2011
		Type	PUBLIC
		Page	16 of 32

### 5.2.6. CONDIAG-MIP, Spanish Government Research Project (2004 – 2006).

The project is focused on the investigation of hardware + software (HW+SW) systems devoted to the sensorless control of electrical drives using Permanent Magnet motors, including both supervised control and maintenance. The investigation is specially applied to the new motors electronically controlled PMSM, Permanent Magnet Synchronous Motor. Specifically, the project aims the development of an Intelligent HW+SW embedded Control for PMSM, able not only of controlling torque and current loops of the motor, but also supervising it for efficiency improvement and predictive maintenance.

The two main objectives of the project are as follows:

- Research and development of innovative control techniques applied to AC permanent magnet synchronous motors, PMSM:
  - o Investigations in the parameters identification and modeling of the new PM motors
  - o Investigations and improvements of the current regulators for standard converters driving PM motors.
  - o Investigations of new power converters and its PWM control, especially matrix converters control, applied to PMSM.
  - o Investigations and development of the new torque control techniques for PM motors, including those related with sensor-less concept.
- Development of an Intelligent System for improving the behavior, security and reliability of the electrical drives using PMSM:
  - o Elaboration and development of plant models in low and high frequency, which will be further used to get useful information from the plant.
  - o Investigations and development of PMSM control techniques for improving the efficiency and reducing power loss.
  - o Analysis of the most frequent causes of failure in PMSM, and investigation and development of new methods for fault detection and diagnosis.
  - o Investigations and development of an Expert System able not only of controlling the drive, but also monitoring it to early fault detection.
  - o Development of an Intelligent Drive based on AI (Artificial Intelligence) able to supervise, complement and improve both the efficiency and the inner torque loop of the motor, harmonically linked thru it.

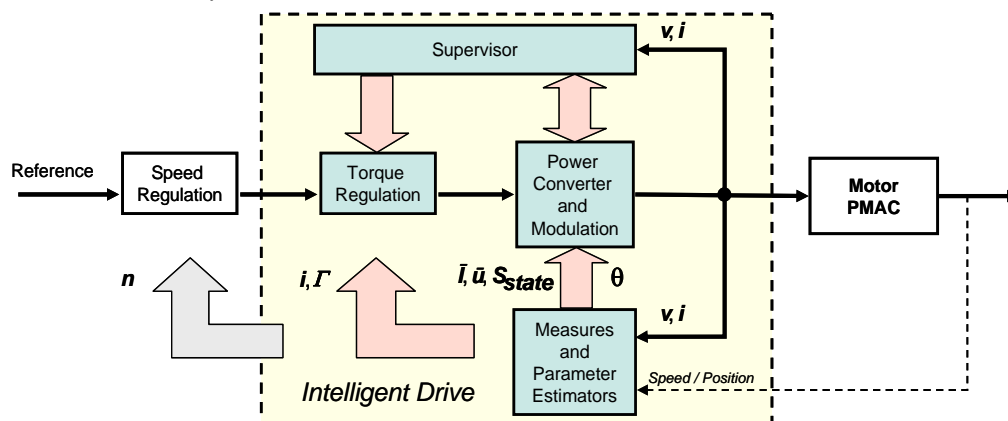



	<b>PROFILE</b>	Author	MCIA Center	
		Code / Rev.	3	
	<b>MCIA CENTER <i>INNOVATIONS ELECTRONICS</i></b>		Date	2011
			Type	PUBLIC
			Page	17 of 32

## 6. List of selected Industrial Projects

It is shown below some significant industrial projects in which the MCIA Center members have participated as leaders or staff of special relevance. The projects are listed in the year they were formalized although some took place in more than one year before:

### *Some 2011 projects:*

- **INMOTICA**

The main objective consists in the development of a new system based on ambient intelligence techniques for lighting management of commercial buildings. This kind of systems are related with different technology aspects like: design of intelligent control systems based on communication protocols for building automation and environmental intelligence techniques, design of specific electronic hardware, programming of distributed computing systems, lighting design and study of new possibilities for environments generation.

- **ARSEA**

The objective of the project is related with the development of new Life Support Systems for artificial aquatic ecosystems, which represent a technological leap in environmental sustainability and costs minimization, maximizing the efficient use of resources. Multidisciplinary fields take part in the project development: knowledge of ecosystems, technical facilities + installation of water treatment, energy facilities optimization, and design and management marine zoos.

### *Some 2010 projects:*

- **SBI Project:**

SBI project is based on characterize the corona effect produced in transmission systems up to  $\pm 800$  kV DC and 1200 kV AC during different environmental conditions. This will permit to optimize and design ultra high voltage connectors and corona shields to withstand at the voltage ranges specified before. In addition, the optimized and designed connectors and shields will be tested and manufactured. Optimization and design goes through chemical, electrical and mechanical coupled FEM method. Summarizing, the aim of this project is to provide consistent technological support and technical guidance to design of new ultra high voltage connection systems.

- **GAVE Project:**

The project involves the design of low voltage breaker (600 V, 200 A) for AC/DC applications. The main problem to solve is the arc extinction system. When the separable contacts of an air circuit breaker are opened, an arc develops between the two contacts. The most common design places the moving contacts inside of an arc chute. We proposes a new design with a insulator system moving between the contacts for arcing extinction which minimizes the chance of a fire and also minimizes damage to the breaker contacts. The project includes the mechanical design also.

	<b>PROFILE</b>	Author	MCIA Center	
		Code / Rev.	3	
	<b>MCIA CENTER <i>INNOVATIONS ELECTRONICS</i></b>		Date	2011
			Type	PUBLIC
			Page	18 of 32

- **OPTIMUS-2:**

This agreement aims to develop a new generation of advanced loudspeaker systems. For that reason, this project aims to research new technologies of amplification, and its application in the field of distributed sound systems, in order to provide high efficiency and quality, which represents a significant improvement compared to other commercial systems.

***Some 2009 projects:***

- **ENERGEST:**

Development of a Monitoring Integrated System in SCADA to get energetic consumes of a production plant of SEAT and to make a forecast of energetic consume for each energy involved. The aim is to know the consume forecast in the plant as a function of production variables by the development of an intelligent software based in artificial intelligence tools. ("Multi-objective Genetic Algorithm", MOGA).

- **MECALUX:**

Monitoring the energetic consume of trans-elevators machine. Development of a software for prediction of energetic consume of a production plant, as well to make an optimized production plan having in mind production variables, times and energy expenditure.

- **MENDESMACO**

The project's main objective is to develop an expert system for evaluation and identification of different defects in composite materials by inspection with nondestructive testing (NDE). The selected composite materials are fiberglass and polyester resin (GRP) and components of carbon fiber and epoxy resin (CFRP). The main non-destructive testing technique to implement the inspection of composite materials is ultrasound, as it is used in parallel screening techniques for imaging and optical techniques.

***Some 2008 projects:***

- **INTEGRA:**

Application of biometric technologies applied to immigration management in borders and Airports. MCIA provides the scientific and technical validation and recommendations for the system at the airport, which includes Biometric Systems and Fault Documentation Systems.

- **GEEAU:**

Evaluation of potential energy savings into Industrial Automatic Storage Facility for a market leader in automatic storage systems.

	<b>PROFILE</b>	Author	MCIA Center
	<b>MCIA CENTER <i>INNOVATIONS ELECTRONICS</i></b>	Code / Rev.	3
		Date	2011
		Type	PUBLIC
		Page	19 of 32

- **OPTIMUS-1:**

Design of three level power amplifier, multi-level, D-Class DCI-NPC for a professional audio system with changing loads.

- **SAIGEE:**

Development of a Management Energy System to improve the reliability of the electrical power in public buildings and industrial plants trough the acquisition, process and presentation of consume data.

- **LAVINIA:**

The project goal is to develop a system able of generate and transmit to-peer real-time video streaming from an independent video camera in an WIMAX environment.

	<b>PROFILE</b>		Author	MCIA Center
			Code / Rev.	3
	<b>MCIA CENTER INNOVATIONS ELECTRONICS</b>		Date	2011
			Type	PUBLIC
			Page	20 of 32

## 7. International Publications

Some of the latest publications as a result of the work developed in the Center are listed below:

<b>Title</b>	Modeling of of Surface-Mounted Permanent Magnet Synchronous Motors With Stator Winding Inter-Turn Faults				
<b>Authors</b>	L. Romeral, J. C. Urresty, J.-R. Riba and A. Garcia.				
<b>Ref.</b>	IEEE Transactions on Industrial Electronics. ISSN : 0278-0046				
<b>Volume</b>	<i>pp</i>	<b>Pages</b>	<i>pp</i>	<b>Date</b>	2011
<b>Title</b>	Feature Extraction of Demagnetization Faults in Permanent-Magnet Synchronous Motors Based on Box-Counting Fractal Dimension				
<b>Authors</b>	M. Delgado, A. G. Espinosa, J.-R. Riba, J. C. Urresty and J. A. Ortega.				
<b>Ref.</b>	IEEE Transactions on Industrial Electronics. ISSN : 0278-0046				
<b>Volume</b>	<i>pp</i>	<b>Pages</b>	<i>pp</i>	<b>Date</b>	2011
<b>Title</b>	Demagnetization Diagnosis in Permanent Magnet Synchronous Motors under Non-Stationary Speed Conditions				
<b>Authors</b>	J.-R. Riba, A. Garcia, L. Romeral and J. Cusidó.				
<b>Ref.</b>	ELSEVIER Electric Power Systems Research. ISSN: 0378-7796				
<b>Volume</b>	80	<b>Pages</b>	1277-1285	<b>Date</b>	October 2010
<b>Title</b>	A simple 2-D finite -Element Geometry for Analyzing Surface-Mounted Synchronous Machines With Skewed Rotor Magnets				
<b>Authors</b>	J. C. Urresty, J.-R. Riba, L. Romeral and A. Garcia.				
<b>Ref.</b>	IEEE Transactions on Magnetics. ISSN: 0018-9464				
<b>Volume</b>	46, 11	<b>Pages</b>	3948-3954	<b>Date</b>	October 2010
<b>Title</b>	Closed-Loop Controller for Eliminating the Contact Bounce in DC Core Contactors				
<b>Authors</b>	A. G. Espinosa, J.-R. Riba, J. Cusidó, L. Romeral and J.A. Ortega.				
<b>Ref.</b>	IEEE Transactions on Components and Packaging Technologies. ISSN: 1521-3331				
<b>Volume</b>	3, 3	<b>Pages</b>	535-543	<b>Date</b>	September 2010
<b>Title</b>	An introduction to fault diagnosis of permanent magnet synchronous machines in master's degree courses				
<b>Authors</b>	J.-R. Riba, A. Garcia, L. Romeral and J.A. Ortega.				
<b>Ref.</b>	Computer Applications in Engineering Education. ISSN: 1061-3773				
<b>Volume</b>	online	<b>Pages</b>	1-11	<b>Date</b>	August 2010
<b>Title</b>	Wavelet and PDD as Fault Detection Techniques				
<b>Authors</b>	J. Cusido, L. Romeral, J. A. Ortega, A. Garcia and J.-R. Riba.				
<b>Ref.</b>	Electric Power Systems Research. ISSN: 0378-7796				
<b>Volume</b>	80, Issue 8	<b>Pages</b>	915-924	<b>Date</b>	August 2010

Page 20

Member of:



MCIA Center – Rambla Sant Nebridi S/N, Edifici GAIA, TR 14  
08222 Terrassa (Spain) info@mcia.upc.edu +34 937 398 530  
www.mcia.upc.edu

	<b>PROFILE</b>	Author	MCIA Center
	<b>MCIA CENTER INNOVATIONS ELECTRONICS</b>	Code / Rev.	3
Date		2011	
Type		PUBLIC	
Page		21 of 32	

<b>Title</b>	Characterization of physical properties of vegetable oils to be used as fuel in diesel engines				
<b>Authors</b>	Jordi-Roger Riba, Bernat Esteban, Grau Baquero, Rita Puig and Antoni Rius.				
<b>Ref.</b>	Asociación de Químicos del Instituto Químico de Sarria . ISSN: 0001-9704				
<b>Volume</b>	66, 546	<b>Pages</b>	100-106	<b>Date</b>	June 2010
<b>Title</b>	On-Line Fault Detection Method for Induction Machines based on Signal Convolution				
<b>Authors</b>	J. Cusidó, L. Romeral, A. Garcia, J. A. Ortega and J.-R. Riba.				
<b>Ref.</b>	European Transactions on Electrical Power. ISSN: 1430-144X				
<b>Volume</b>	21	<b>Pages</b>	475-488	<b>Date</b>	May 2010
<b>Title</b>	A Computer Model for Teaching the Dynamic Behavior of AC Contactors				
<b>Authors</b>	J.-R. Riba, A. Garcia and J. L. Romeral.				
<b>Ref.</b>	IEEE Transactions on Education. ISSN: 0018-9359				
<b>Volume</b>	53, 2	<b>Pages</b>	248-256	<b>Date</b>	May 2010
<b>Title</b>	Electrical Monitoring for Fault Detection in an EMA				
<b>Authors</b>	L. Romeral, J. Rosero, A. Garcia, J. Cusidó and J. A. Ortega.				
<b>Ref.</b>	IEEE Aerospace & Electronics Systems Magazine. ISSN: 0885-8985				
<b>Volume</b>	25, 3	<b>Pages</b>	4-9	<b>Date</b>	March 2010
<b>Title</b>	Small-scale production of straight vegetable oil from rapeseed and its use as biofuel in the Spanish territory				
<b>Authors</b>	G. Baquero, B. Esteban, A. Rius, J.-R. Riba and R. Puig.				
<b>Ref.</b>	ELSEVIER Energy Policy. ISSN: 0301-4215				
<b>Volume</b>	38	<b>Pages</b>	189-196	<b>Date</b>	January 2010
<b>Title</b>	Short-Circuit Detection by Means of Empirical Mode Decomposition and Wigner-Ville Distribution for PMSM Running Under Dynamic Condition				
<b>Authors</b>	J.A. Rosero, L. Romeral, J. A Ortega and E. Rosero.				
<b>Ref.</b>	IEEE Transactions on Industrial Electronics. ISSN : 0278-0046				
<b>Volume</b>	56, 11	<b>Pages</b>	4062-4070	<b>Date</b>	November 2009
<b>Title</b>	Motor Fault Detection Using a Rogowski Sensor without an Integrator				
<b>Authors</b>	O. Poncelas, J.A. Rosero, J. Cusidó, J. A. Ortega and L. Romeral.				
<b>Ref.</b>	IEEE Transactions on Industrial Electronics. ISSN : 0278-0046				
<b>Volume</b>	56, 10	<b>Pages</b>	4062-4070	<b>Date</b>	October 2009
<b>Title</b>	Improving the control of the cement-making process by applying multivariate classical least squares calibration				
<b>Authors</b>	J.-R. Riba, J. Font, D. Rodríguez and R. Puig.				
<b>Ref.</b>	Revista de química y teórica aplicada. ISSN: 0001-9704				

	<b>PROFILE</b>		Author	MCIA Center
			Code / Rev.	3
	<b>MCIA CENTER INNOVATIONS ELECTRONICS</b>		Date	2011
			Type	PUBLIC
			Page	22 of 32

<b>Volume</b>	67, 543	<b>Pages</b>	1-7	<b>Date</b>	October 2009
<b>Title</b>	Detection of Demagnetization Faults in Permanent-Magnet Synchronous Motors Under Nonstationary Conditions				
<b>Authors</b>	J.-R. Riba, J.A. Rosero, A. Garcia and L. Romeral.				
<b>Ref.</b>	IEEE Transactions on Magnetics. ISSN: 0018-9464				
<b>Volume</b>	45, 7	<b>Pages</b>	2961-2969	<b>Date</b>	July 2009
<b>Title</b>	Fault Detection by Means of Hilbert–Huang Transform of the Stator Current in a PMSM With Demagnetization				
<b>Authors</b>	A. G. Espinosa, J. A. Rosero, J. Cusido, L. Romeral and J. A. Ortega.				
<b>Ref.</b>	IEEE Transactions on Energy Conversion. ISSN : 0885-8969				
<b>Volume</b>	25, 2	<b>Pages</b>	4062-4070	<b>Date</b>	June 2010
<b>Title</b>	Magnetic Field Generated by Sagging Conductors of Overhead Power Lines				
<b>Authors</b>	J.-R. Riba and A. Garcia.				
<b>Ref.</b>	Computer Applications in Engineering Education. ISSN: 1099-0542				
<b>Volume</b>	online	<b>Pages</b>	1-10	<b>Date</b>	April 2009
<b>Title</b>	Validation of the Parametric Model of a DC Contactor Using Matlab-Simulink				
<b>Authors</b>	J.-R. Riba, A. Garcia and J. A. Ortega.				
<b>Ref.</b>	Computer Applications in Engineering Education. ISSN: 1099-0542				
<b>Volume</b>	online	<b>Pages</b>	1-12	<b>Date</b>	March 2009
<b>Title</b>	Electric Field Effects Of Bundle And Stranded Conductors In Overhead Power Lines				
<b>Authors</b>	J.-R. Riba, A. Garcia and X. Alabern.				
<b>Ref.</b>	Computer Applications in Engineering Education. ISSN: 1099-0542				
<b>Volume</b>	online	<b>Pages</b>	1-8	<b>Date</b>	February 2009

	<b>PROFILE</b>	Author	MCIA Center
	<b>MCIA CENTER INNOVATIONS ELECTRONICS</b>	Code / Rev.	3
		Date	2011
		Type	PUBLIC
		Page	23 of 32

## 8. Patents

Due to the different Works related with the technological transfer or research activities, the center has active patents and patents in process of acceptance. The last significant patents are:

<b>Title</b>	Bearings diagnosis equipment.		
<b>Authors</b>	J. Cusidó, L. Romeral, J. A. Ortega, A. G. Espinosa, M. Delgado and O. Poncelas.		
<b>Ref.</b>	US201070277199 A1. 04/11/2010		
<b>Propietary</b>	Technical University of Catalonia (UPC).	<b>Date</b>	2010
<b>Title</b>	Speaker diagnosis system by ZAM transformation and using procedure.		
<b>Authors</b>	G. Ruiz, J. A. Ortega and V. Sala.		
<b>Ref.</b>	P201001423. 02/11/2010		
<b>Propietary</b>	Technical University of Catalonia (UPC).	<b>Date</b>	2010
<b>Title</b>	Speaker diagnosis system by Wavelet transform and using procedure.		
<b>Authors</b>	V. Sala, J. Cusidó and L. Romeral.		
<b>Ref.</b>	P201001425. 02/11/2010		
<b>Propietary</b>	Technical University of Catalonia (UPC).	<b>Date</b>	2010
<b>Title</b>	Mechatronic actuators diagnosis system by fuzzy logic and using procedure.		
<b>Authors</b>	J. Cusidó, L. Romeral, M. Delgado, V. Sala and L. Navarro.		
<b>Ref.</b>	P201001196. 10/09/2010		
<b>Propietary</b>	Technical University of Catalonia (UPC).	<b>Date</b>	2010
<b>Title</b>	Inverter with redundant branches per phase for multiphase motors and using procedure.		
<b>Authors</b>	J. Cusidó, V. Sala and L. Romeral.		
<b>Ref.</b>	P201031352. 10/09/2010		
<b>Propietary</b>	Centre Tecnològic (CTM)	<b>Date</b>	2010

	<b>PROFILE</b>	Author	MCIA Center
		Code / Rev.	3
	<b>MCIA CENTER INNOVATIONS ELECTRONICS</b>	Date	2011
		Type	PUBLIC
		Page	24 of 32

## 9. Organization and management of the investigation

The organization and management of the investigation in the MCIA Center is promoted constantly in two directions:

- The first one is based on the *organization and/or participation in courses*, with teaching activity as specialized investigators and developers of products. In this sense, the Center is able of acquire and share the specialized knowledge with professionals. As examples:
  - Organization of the 10th Flux conference for investigators that took place in UPC Campus of Terrassa and Barcelona.
  - Participation in the project financed by European Community Car Ecology, based on the development of an European Master about electric and hybrid vehicle technologies. The project is developed in collaboration with different European Universities.
- The second line is based on the *management of industrial projects*. One of the main strategic points in the Center is the development and management of projects directly related with the research lines of the Center. For that reason, the implementation of latest innovations and patents generation is possible.

These facts make MCIA Center recognized by its innovation and capacity of technologic transference by the *Departament d'Innovació, Universitats i Empresa (ACC10)* of Generalitat de Catalunya (Country Government), taking part of the net of *Technological Transference Centers of Catalunya (TECNIO)*. At the same time, the academic and scientific aspects of the MCIA Center are recognized by the *Agència de Gestió d'Ajuts Universitaris i de Recerca of Generalitat de Catalunya (AGAUR)*, that considers the group as a consolidated group of investigation.



**Agència  
de Gestió d'Ajuts  
Universitaris  
i de Recerca**



	<b>PROFILE</b>	Author	MCIA Center	
		Code / Rev.	3	
	<b>MCIA CENTER <i>INNOVATIONS ELECTRONICS</i></b>		Date	2011
			Type	PUBLIC
			Page	25 of 32

## 10. Infrastructure and technical equipment

MCIA Center has, apart from qualified staff, great infrastructure and technical equipment to perform the investigation and research with the highest expectations. The center, addition to offices and meeting rooms, has four specialized laboratories where the working areas are distributed.

### ***Electronic Applications Lab***

Electronic Applications Lab of MCIA Center is 74 m<sup>2</sup> distributed in 10 workplaces. The projects and Studies that are made in this lab are related with different working areas, such as: Power Electronics, Digital Systems, Electronic Instrumentation, Telecommunication Systems, Control Systems and Electro-acoustic Systems.

This lab arranges equipment and instrumental needed to deal with any kind of project in this area.

- Control and Simulation system HIL “Hardware In the Loop” dSPACE (Matlab-Simulink)
- Control and Simulation system HIL “Hardware In the Loop” PXI National (Lab-View)
- Systems and Platforms of Prototyped DSP and FPGA
- Equipment PM600 Voltech of Power Quality Measurements DC-15MHz 20000Vpk
- Oscilloscopes TDS 2 Channels Tektronix
- Oscilloscopes and Logic Analyzers Agilent
- Oscilloscopes TPS2024 4 Channels 200MHz Power Tektronix
- Oscilloscope DPO7054 4 Channels 500MHz Tektronix
- Symmetrical Lab Power Supply, Triple of 30W – 50W (Agilent)
- Power supply (3kW) XFR Xantrex
- RLC Meters
- Distortion analyzer PM6304 (Philips)
- Active components analyzer
- Programmable signal generators 20MHz (Agilent)
- Differential Voltage Probes Tektronix
- High Voltage Probes Tektronix
- Active and Passive Current Probe
- Active High Frequency Current Probe
- Power R-L\_C Loads
- Welding Station SMD
- Mechanized and Prototyped workbench
- Anti ESD Workbench
- 7 PCs (Pentium IV or Higher)
- 2 Laptops ( Pentium IV or Higher)



*MCIA Electronic Applications Laboratory*



*Power Electronics Bench*



*Digital Electronic Bench*

	<b>PROFILE</b>	Author	MCIA Center
		Code / Rev.	3
	<b>MCIA CENTER INNOVATIONS ELECTRONICS</b>	Date	2011
		Type	PUBLIC
		Page	26 of 32

## ***Mechatronic Systems Lab***

Mechatronic Systems Lab is 58 m<sup>2</sup> distributed in 5 working places. As well has 4 Experimental Benches equipped with 2 Electrical Motors each one, and all the infrastructure needed to control the motors and to acquire the electrical and mechanical measurements. In this lab, simulations and experimental projects about diagnosis and prognosis of all kinds of electronic actuators are made.

- Induction Motors Workbench 1,1kW
- PMSM Motors Workbench 1,45kW
- PMSM Motors Workbench 1,45kW with screw actuator
- Induction Motors and PMSM motors workbench 1,1 kW
- Power cabinet with Inverter outputs of 1,5kW y 14kW
- Power cabinet with Inverter outputs of 2kW
- Control and Simulation system HIL “Hardware In the Loop” dSPACE (Matlab-Simulink)
- Control and Simulation system HIL “Hardware In the Loop” PXI National (Lab-View)
- Systems and Platforms of Prototyped DSP and FPGA
- Equipment PM600 Voltech of Power Quality Measurements DC-15MHz 20000Vpk
- Oscilloscopes TDS 2 Channels Tektronix
- Oscilloscopes TPS2024 4 Channels 200MHz Power Tektronix
- Symmetrical Lab Power Supply, Triple of 30W – 50W (Agilent)
- RLC Meters
- Programmable signal generators 20MHz (Agilent)
- Differential Voltage Probes Tektronix
- High Voltage Probes Tektronix
- Active and Passive Current Probe
- Current Probe TCP303 and amplifier TCPA300, DC-15MHz, 150A DC
- Current Probe TCP0030, DC-120MHz, 30A
- Power R-L\_C Loads
- LASER 3D System of axles alignment
- 7 PCs (Pentium IV o Higher)
- 2 Laptops ( Pentium IV o Higher)
- 1 PC Programable Tactile Industrial (Mobile Genuine Intel)
- 1 PC Shuttle of Adquisition Measurements



*Motor Control Bench*

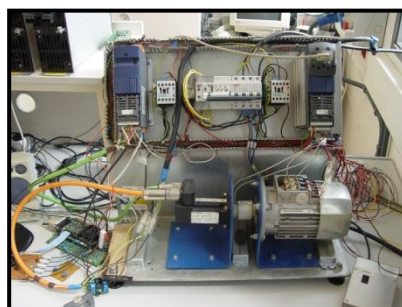

*Motor Control Bench*

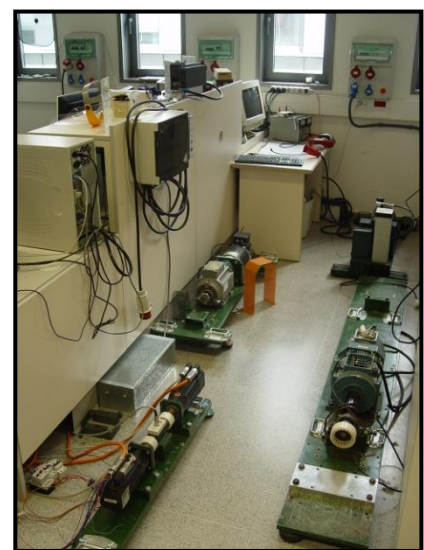

*PMSM Experimental Bench*

	<b>PROFILE</b>	Author	MCIA Center
		Code / Rev.	3
	<b>MCIA CENTER INNOVATIONS ELECTRONICS</b>	Date	2011
		Type	PUBLIC
		Page	27 of 32

### Simulation Lab

The Simulation Lab has the aim to give Simulation Software support to different projects and studies that are made in both Hardware labs of the MCIA Center.

Nowadays, the lab has 8 PC's that are able to run simulations in:

- FLUX, Simulations 2D and 3D FEM (Finite Elements Model)
- MATLAB and MATLAB-Simulink
- Lab-View
- Orcad – PSPICE
- Multisim
- PSIM
- Design and Simulation with Protel XP Altium



View of Protel DXP Design

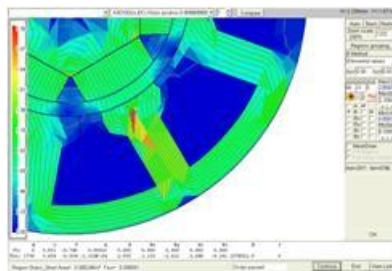

View of Flux Model

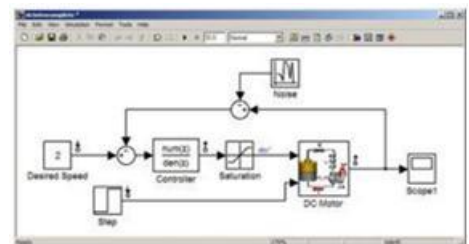

View of Simulink Model

### Remote Systems Laboratory

These Laboratories are used for demonstrations and lab lessons for universities courses (1st cycle, 2nd cycle engineering, and Master Degrees).



Motor and Drives remote laboratory

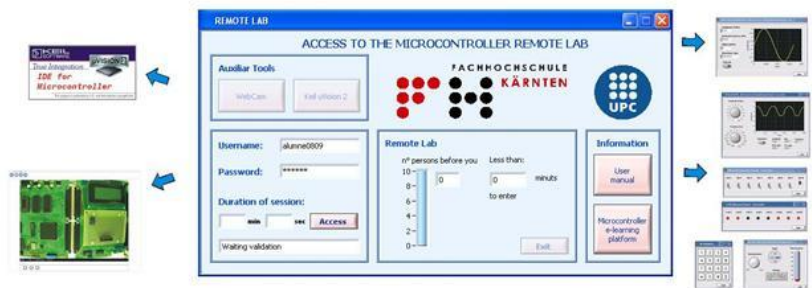

Digital applications remote laboratory

	<b>PROFILE</b>	Author	MCIA Center
	<b>MCIA CENTER <i>INNOVATIONS ELECTRONICS</i></b>	Code / Rev.	3
		Date	2011
		Type	PUBLIC
		Page	28 of 32

## 11. Formation Capabilities

### a) Formation of investigation staff by means of doctoral thesis, dissertations and final projects direction.

The MCIA Center accumulates a large experience in the investigation staff by means of thesis direction, and plans carrying on with this philosophy with several theses that are in process right now.

Presented:

1. Study of fault condition effects and new monitoring techniques based on MCSA improvements for Induction Machines under non constant load conditions.  
*Jordi Cusidó Roura. Year: 2008*
2. Study of PMSM failures and its detection by means of Stator Current Analysis.  
*Javier Alveiro Rosero García. Year: 2007*
3. Contributions to the stability analysis of Adaptive Regulators for mechatronic systems.  
*Mohamed Rachid Chekkouri. Year: 2004.*
4. Speed estimation for Vector Control of Induction Motors.  
*Jordi Catalá i López. Year: 2003.*
5. Three Phase Current Regulators at low-Switching Frequency and reduced harmonic contents.  
*Emiliano Aldabas Rubira. Year: 2002.*
6. Improvements in Direct Torque Control of Induction Motors.  
*Antoni Arias i Pujol. Year: 2001.*
7. Adaptative Vectorial Control of Asynchronous Induction Motors.  
*David Juan Bedford Gaus. Year: 1999.*

	<b>PROFILE</b>	Author	MCIA Center
		Code / Rev.	3
	<b>MCIA CENTER INNOVATIONS ELECTRONICS</b>	Date	2011
		Type	PUBLIC
		Page	29 of 32

Under Development:

1. Efficient management of energy in Industrial Installations and Microgrids by means of Expert Systems.  
*Juan Jose Cardenas Araujo*
2. New Diagnosis and Prognosis Techniques for High Efficient Electric Actuators in steady state and transient operations conditions.  
*Miguel Delgado Prieto*
3. Fault Detection and Diagnosis for predictive maintenance of mechatronic systems.  
*Julio Cesar Urresty*
4. Fault Detection and Diagnosis by means of Acoustic Emissions for mechatronic systems.  
*Luis Miguel Navarro*
5. Loudspeakers diagnosis by means of electrical signals analysis  
*Germán Ruiz Illana*
6. New Control Strategies for Distortion Canceling in Audio Switching DCI-NPC Amplifiers  
*Vicent Sala Caselles*
7. Study of stability and design of no-lineal controllers in Microgrid  
*Fabio Andrade Rengifo*
8. Modelling and computation of plasma physics for high voltage applications based on coupled FEM method to optimize and develop advanced connection systems for energy transmission.  
*Joan Hernández Guiteras*
9. Research on Axial Flux Permanent Magnet Motor Drive for In-Wheel Car Applications  
*Ramin Salehi Arashloo*
10. Study of Axial Flux Permanent Magnet Fault tolerant motor  
*Harold Saavedra*

	<b>PROFILE</b>	Author	MCIA Center
	<b>MCIA CENTER <i>INNOVATIONS ELECTRONICS</i></b>	Code / Rev.	3
		Date	2011
		Type	PUBLIC
		Page	30 of 32

**b) Formation of investigation staff by means of courses and seminars.**

Apart from doctoral thesis direction, the center promotes continued formation of its members as well as the formation in new technologies and development tools. An interesting example of this training is the assistance to courses and specialized seminars. Some of these courses attended by MCIA Center team during the last year are as follows:

- Simulation Software Simulation Course of Finite Elements Model, FLUX.  
*Conducted by the CEDRAT company.*
- Advanced Courses for PCB prototypes generation by means of Protel.  
*Conducted by the Altium company.*
- Presentation Seminars and Advanced use of LabView systems.  
Advanced systems of signal acquisition.  
Software Applications to routine development.  
Simulation System HiL.
- Advanced Seminary of Frequency Controllers ABB management.  
*Conducted by the company ABB.*
- Advanced Seminary of new tools to measure the power quality.  
*Conducted by the company Voltech – Megacal*
- Workshop about Synthesitation software in FPGA “Synplify Pro / Synplify DSP”

Also, aspects such as planning, hygiene and safety, optimization of time, resources, new tendencies and lab and personal management tools get special importance at the technical staff formation:

- Course: “Advanced Management of multiple priorities” conducted by AV RRHH, Servei de Desenvolupament Professional, UPC.
- Basic Course of occupational hazards prevention (PRL), 30 hours, accredited by Asepeyo

	<b>PROFILE</b>	Author	MCIA Center
		Code / Rev.	3
	<b>MCIA CENTER <i>INNOVATIONS ELECTRONICS</i></b>	Date	2011
		Type	PUBLIC
		Page	31 of 32

## 12. Human Resources Capacities

Human resources in the MCIA Center is organized in three parts: the group of Professors (Doctors) of University, the group of Technicians of maintenance and logistics and the team of Investigators dedicated to research and develop the projects. These three groups are related in an organization chart where are structured the responsibilities and collaboration that make the MCIA Center able to develop its activity in a constant way. To be more precise, the MCIA center consists of the following people:

Dr. José Luis Romeral	-	Director
Dr. Juan Antonio Ortega	-	Director
Dr. Antoni Garcia	-	Head Researcher
Dr. Jordi Riba	-	Head Researcher
Dr. Jordi Cusidó	-	Head Researcher
Dr. Juan Manuel Moreno	-	Head Researcher
Dr. Javier Alveiro Rosero	-	Consultant engineer
Mr. Eulogio Almudevar	-	Consultant engineer
M. Eng. Kostas Kabouropoulos	-	Laboratory Technician
M. Eng. Enrique Nares	-	Laboratory Technician
Mr. Martí Cobo	-	Laboratory Technician
Ms. Esther López	-	Administrative assistant
M.Eng. Jordi Llaquet	-	Researcher
M. Eng. Juan José Cárdenas	-	Researcher
M. Eng. Miguel Delgado	-	Researcher
M. Eng. Vicenç Sala	-	Researcher
M. Eng. Julio Urresty	-	Researcher
M. Eng. Germán Ruiz	-	Researcher
M. Eng. Fabio Andrade	-	Researcher
M. Eng. Harold Saavedra	-	Researcher
M. Eng. Ramin Salehi	-	Researcher
M. Eng. Joan Hernandez	-	Researcher
M. Eng. Oriol Torres	-	Researcher
M. Eng. Benjamin Bader	-	Researcher
M. Eng. Luis Miguel Navarro	-	Researcher

Moreover, the Center has a continuous collaboration with students as placements to carry out tasks of maintenance in the labs and collaborations in research projects.

	<b>PROFILE</b>	Author	MCIA Center
	<b>MCIA CENTER <i>INNOVATIONS ELECTRONICS</i></b>	Code / Rev.	3
		Date	2011
		Type	PUBLIC
		Page	32 of 32

## 13. Potential options of collaboration

### 13.1. Student stays in the Center

The MCIA Center usually has small and medium projects that master students can participate, in order to gain experience in an international environment outside their country.

Also, international projects in which MCIA is involved need, in many times, of the participation of qualified students, who can develop master thesis or industrials stays as a part of an international engineering staff. The MCIA center offers and maintains student's grants or contracts to help interested people during their stay.

### 13.2. Visiting professor stays in the Center

International relationships between researchers and professors are always welcome. Furthermore, the MCIA Center might have some short term need of highly qualified researchers, to participate, develop or leading international projects. Also, MCIA Center is interested in advanced educational tools and procedures, to acquire and improve educational skills for all its members.

### 13.3. Ph. D. Student Positions in the Center

The MCIA Center sometimes has long term projects where budget is available to fund a thesis for foreign people. On the other hand, MCIA can promote and support students' applications to Spanish Grants for Ph.D. studies, which are about 15k€/year. Thesis duration lasts for a time between three and four years, and part of the work might be developed in the student's country.

### 13.4. Partnership for Collaborative projects

Participation in European Projects is a key for the MCIA Center, and it usually gets involved into European Research collaboration projects where partners from different countries are required. The MCIA center would be very happy to start collaboration with any member state of the European Union participating as either Leader or Research Center. MCIA is interested in areas of its experience, or any other related to social or industrial applications of the electronics.